

MARIOLINA

by e-ggs



Mariolina è nata esplorando il mondo del polipropilene e i suoi nuovi sviluppi, abbinandosi delicatamente ad una estetica essenziale. La scocca è così semplice che puoi disegnarla senza staccare la penna dal foglio, bilanciando uno stile curato e attento al presente con la volontà di uscire dalle mode. Mariolina è la risposta alla necessità di un prodotto eclettico, realizzato con un metodo produttivo contemporaneo e adatto alla vita di tutti i giorni.

Mariolina came from an exploration into the world of polypropylene and its new developments, combining it with a delicate, honest aesthetic. The body is so simple that it can be drawn without the pen leaving the paper, balancing a careful style, attentive to the present, with the desire to break free of fashion.

Mariolina is the answer to the need for an eclectic product, made with a contemporary production method and suitable for everyday life.

DIMENSIONI | DIMENSIONS

BASIC | BASIC

lunghezza | width: 55 cm

larghezza | depth: 54 cm

altezza | height: 79 cm

altezza del sedile | seat height: 46,7 cm

impilabilità | stackability: sì (X4) | yes (X4)

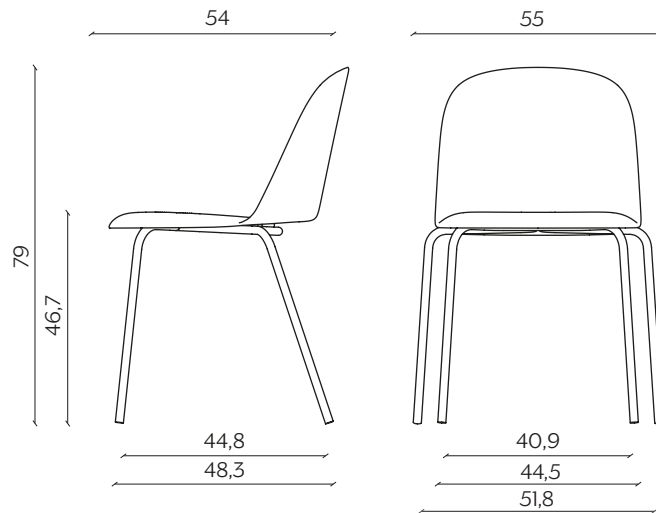

GAMBE IN LEGNO | WOODEN LEGS

lunghezza | width: 46 cm

larghezza | depth: 54 cm

altezza | height: 79 cm

altezza del sedile | seat height: 46,7 cm

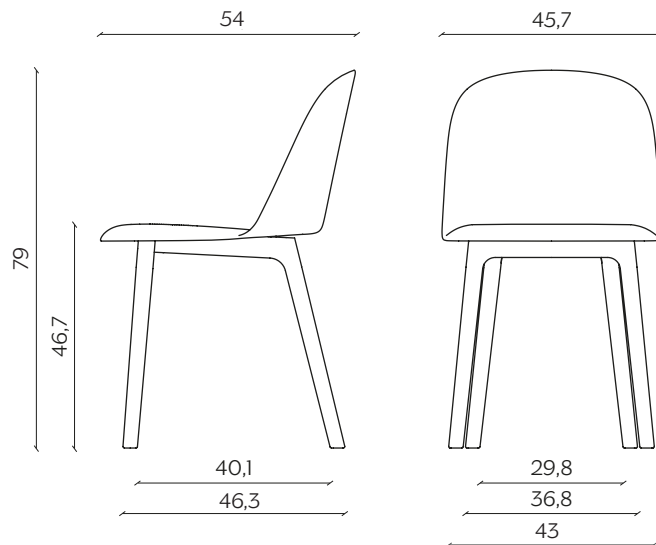

AMBIENTE | ENVIRONMENT

interno, esterno (solo su base laccata e senza cuscino sedile)

indoor, outdoor (only on lacquered base and without seat cushion)

SLITTA | SLED BASE

lunghezza | width: 54 cm

larghezza | depth: 53 cm

altezza | height: 79

altezza del sedile | seat height: 46,2 cm

impilabilità | stackability: sì (X4) | yes (X4)

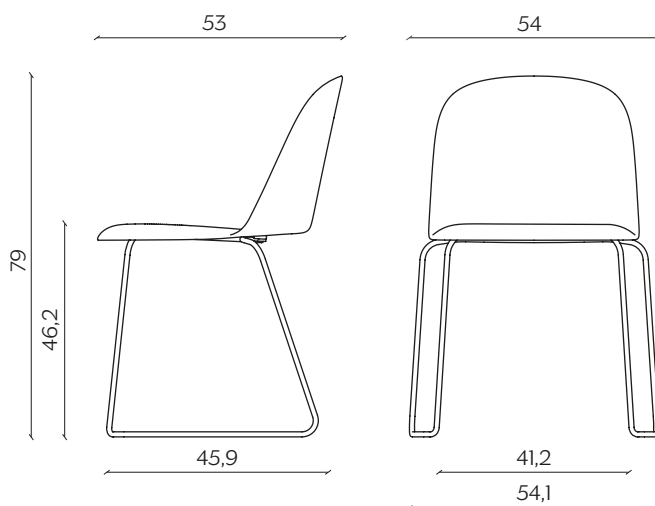

UFFICIO | OFFICE

lunghezza | width: 45,6 cm

larghezza | depth: 53 cm

altezza | height: 78,5

altezza del sedile | seat height: 46,2

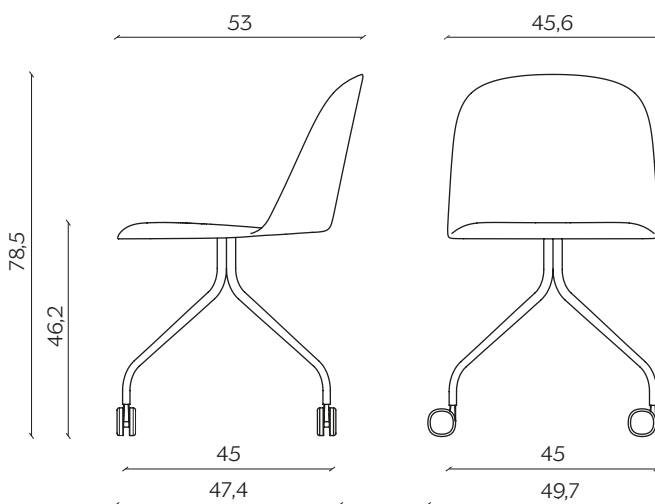

DOWNLOAD | DOWNLOADS

la guida Cura e Manutenzione è disponibile su miniforms.com
Care and Maintenance guide is available at miniforms.com

file 2D, 3D e fotografie sono disponibili su miniforms.com
2D, 3D files and hi-res images are available at miniforms.com

FINITURE | FINISHES

GAMBE | LEGS

Legno | Wood



Frassino
Ash



Frassino Nero
Black Ash



Rame
Copper

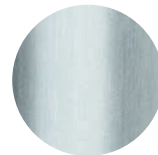

Zincato
Zinc-coated

Metallo | Metal

GAMBE E SCOCCA | LEGS AND SHELL

Laccato | Lacquer

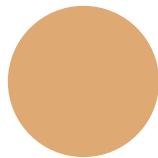

Albicocca
Apricot

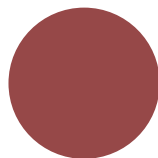

Rosso Marsala
Marsala Red

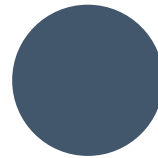

Blu Intenso
Intense Blue



Antracite
Anthracite

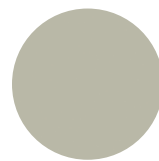

Grigio Seta
Silk Grey

FINITURE | FINISHES

TESSUTI | FABRICS

A

Salò

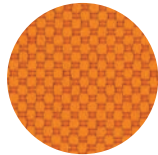

Arancio
Orange

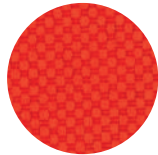

Rosso
Red



Marmellata
Jam

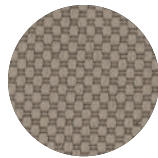

Grigio Chiaro
Light Grey



Marrone
Brown

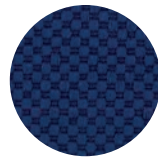

Blu Notte
Midnight Blue

Loop

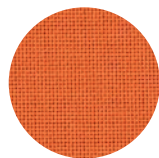

Arancione
Orange

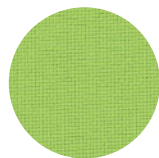

Lime

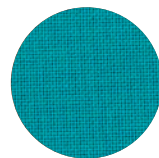

Turchese
Turquoise

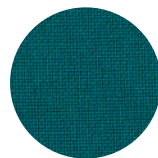

Ottanio
Teal Green

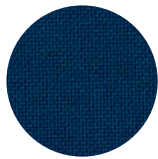

Blu Scuro
Dark Blue



Testa di Moro
Dark Brown

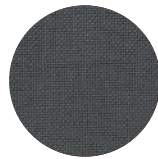

Grigio Fumo
Smoke Grey

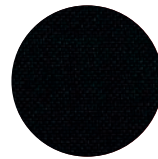

Nero
Black

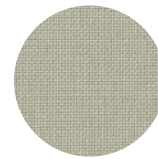

Avorio
Ivory

TESSUTI | FABRICS

A

Tramè



Beije

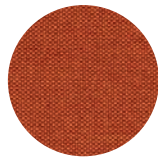

Arancio
Orange

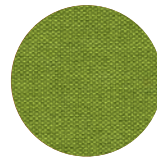

Mela
Apple

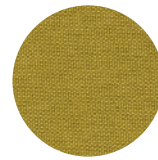

Senape
Mustard

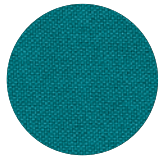

Pavone
Peacock

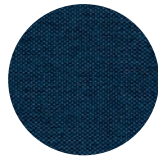

Blu Elettrico
Electric Blue



Nero
Black

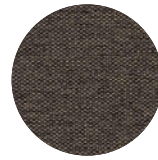

Crigio Scuro
Dark Grey

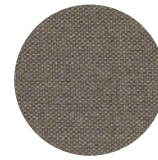

Tortora
Dove Grey

Madrid

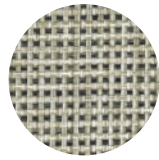

Burro
Butter

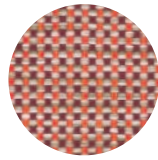

Melograno
Pomegranate



Menta
Mint

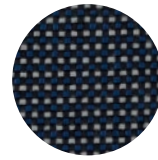

Notte
Night

FINITURE | FINISHES

TESSUTI | FABRICS

B

Kvadrat Relate



Rosa
Pink

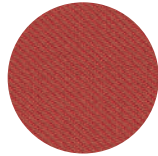

Rosso
Red

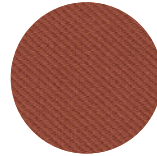

Terra
Ground

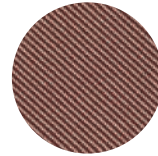

Snack

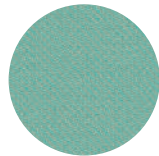

Menta
Mint

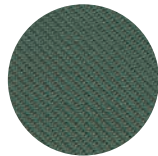

Verde Bosco
Forest Green

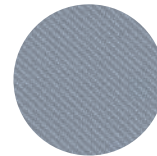

Nuvolo
Cloudy

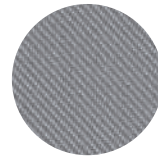

Grigio
Grey

Lanee

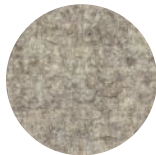

Grigio
Grey

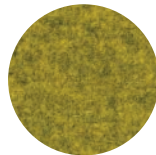

Giallo
Yellow

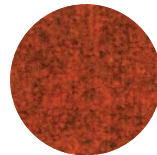

Rosso
Red

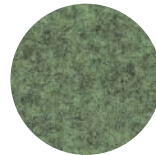

Menta
Mint

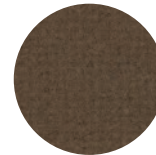

Marrone
Brown

TESSUTI | FABRICS

B

Torrilana Cubbio

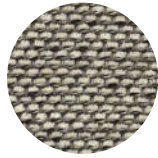

Sale e Pepe
Salt and Pepper

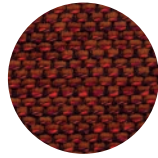

Ambra
Amber

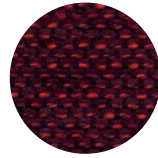

Bordeaux

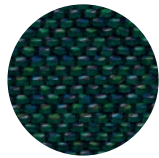

Verde Petrolio
Petrol Green

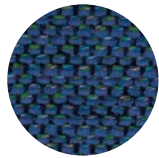

Blu Elettrico
Electric Blue



Castagna
Walnut

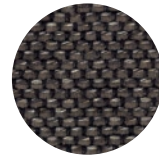

Tortora
Dove Grey

Mesh

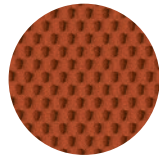

Rosso Corallo
Coral Red

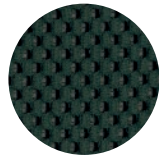

Verde Salvia
Sage Green

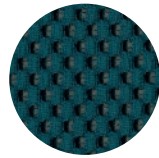

Foglia di Tè
Teal

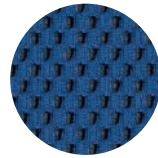

Blu Neon
Neon Blue

FINITURE | FINISHES

TESSUTI | FABRICS

C

Shelter Velvet



Crema
Cream



Rosa Intenso
Intense Rose



Terra di Siena
Burnt Sienna



Cammello
Camel

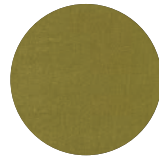

Verde
Green

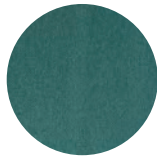

Turchese
Turquoise



Blu Notte
Midnight Blue

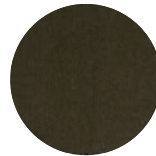

Testa di Moro
Dark Brown

Kvadrat Field 2

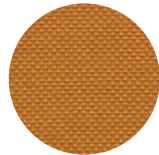

Zafferano
Saffron-Yellow

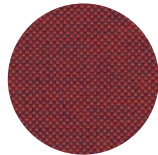

Ciliegia
Cherry

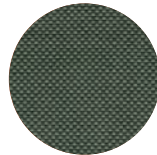

Menta
Mint

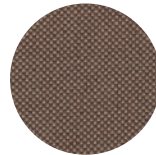

Nocciola
Hazel

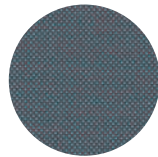

Zucchero
Sugar

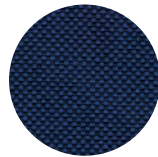

Blu
Blue

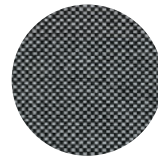

Sale e Pepe
Salt and Pepper

Torrilana Brionne



Black and White

TESSUTI | FABRICS

C

Vescom Harding

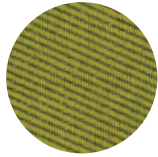

Ciallo
Yellow

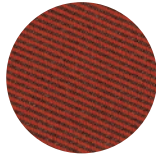

Rosso
Red

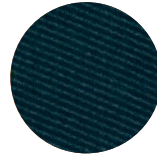

Petrolio
Blue-Green

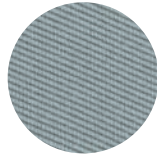

Grigio Chiaro
Light Grey

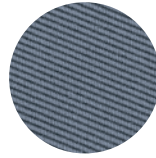

Nuvolo
Cloudy

Vescom Rolla

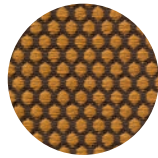

Mostarda
Mustard

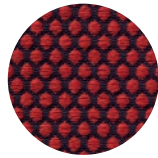

Ciliegia
Cherry

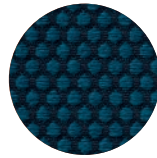

Blu Pavone
Peacock

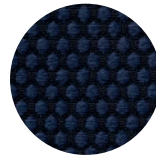

Blu Notte
Midnight Blue

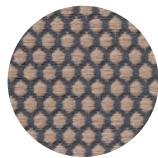

Latte
Steamed Milk

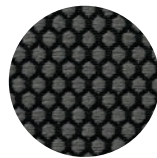

Antracite
Anthracite

Torrilana Rakam



Bacca
Berry

FINITURE | FINISHES

TESSUTI | FABRICS

D

Cloud



Panna
Cream



Noce
Walnut



Nocciola
Hazelnut

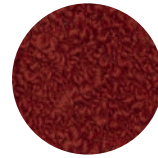

Bordeaux

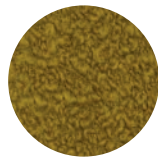

Senape
Mustard

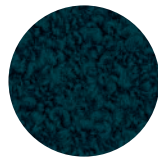

Petrolio
Blue-Green

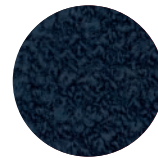

Blu Notte
Night Blue

Maharam Merit

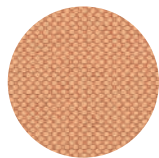

Salmone
Salmon

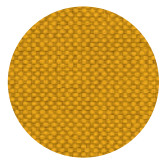

Ciallo
Yellow

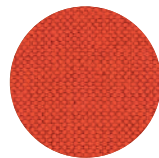

Rosso Corallo
Coral Red



Marrone
Brown

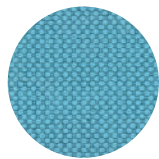

Celeste
Sky Blue

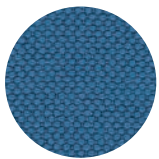

Blu Cobalto
Cobalt Blue

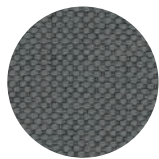

Grigio
Grey

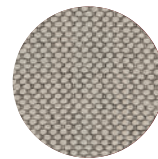

Sale e Pepe
Salt and Pepper

TESSUTI | FABRICS

D

Rohi Sera

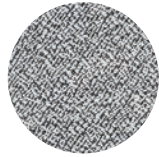

Pepper

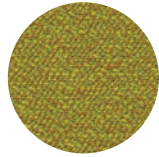

Tivoli

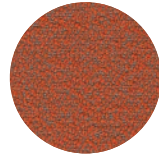

Glow

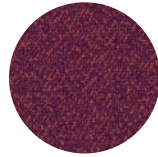

Berry

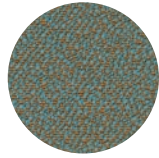

Mirage

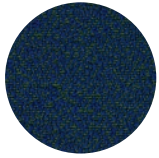

Mare

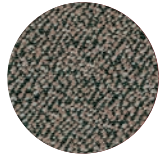

Walnut



Rosewood

Rohi Mica

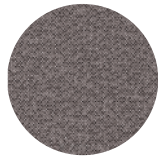

Pepper

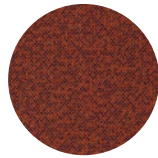

Indio

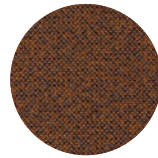

Amber

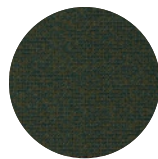

Jungle

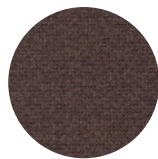

Mud

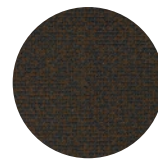

Secret

FINITURE | FINISHES

TESSUTI | FABRICS

E

Kvadrat Steelcut Trio 3

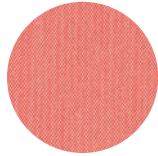

Arancia Rossa
Red Orange



Pavone
Peacock

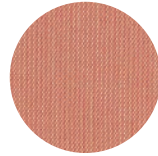

Pesca
Peach



Sale e Pepe
Salt and Pepper



Elettricità
Electricity